



DVR/NVR



CAMERA



ACCESSORY



SOFTWARE

Network Camera

NK1080D-F2.8

SONY STARVIS | Onvif | PoE



Key Features

- 1/2.8", 2.1M Sony STARVIS Image Sensor
- Supports 2 H.264 streams including 1920x1080 30fps and 1 JPEG stream
- Max 6 streams connection simultaneously (3 users based on NVR)
- 3DNR (Noise reduction)
- Digital Image Stabilizer (DIS)
- True Day&Night (ICR)
- Support De-Fog function
- Supports Onvif / PoE
- Supports IPv4

Dimension

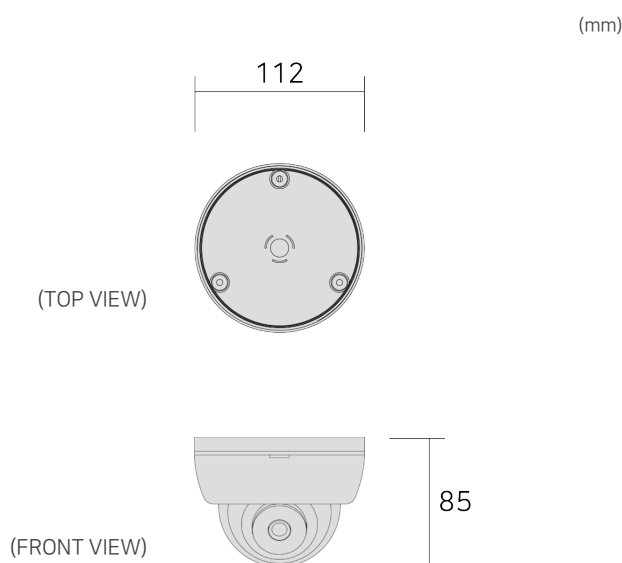

Tech Note

SONY STARVIS Image Sensor

Highly sensitive SONY STARVIS CMOS Sensor provides crystal clear image in low light condition.

Higher performance SoC

High performance ISP functions such as 3DNR, WDR, and etc.
Revolutionary response speed and stabilized performance.

3D-DNR 3D-Digital Noise Reduction

Advanced 3D-DNR technology detects and eliminates unnecessary noise by conducting comprehensive analysis of image pixels.

WDR Wide Dynamic Range

Realize one clear image by combining overexposed and underexposed identical images in backlight condition.

Made in Korea

Different league from low priced Chinese products.
Proven quality of Made in Korea and reasonable price.



DVR/NVR



CAMERA



ACCESSORY



SOFTWARE

Network Camera

NK1080D-F2.8



CAMERA		
Sensor Type	1/2.8", 2.1Megapixel Sony STARVIS Sensor	
Sensor Pixels	1920(H) × 1080(V) = 2.1M pixels	
Scanning System	Progressive Scan	
Min. Illumination	Color	0.2Lux@50IRE / F1.2 / 3100K / AGC:10
	B/W	0.0005Lux@50IRE / F1.2 / 3100K / AGC:10
Lens	Filter	True Day & Night (ICR)
	Type	2.8mm Fixed Mega Pixel Lens
Camera Functions	Day & Night	AUTO / COLOR / BW / EXTERN
	WDR	LOW / MIDDLE / HIGH
	BLC	OFF / ON
	HCL	LEVEL(0~20) / COLOR
	AGC	0~10
	ACE	OFF / LOW / MIDDLE / HIGH
	DNR	OFF / LOW / MIDDLE / HIGH
	DSS	OFF / AUTO / x2 / x4 / x8 / x16 / x32
	SHARPNESS	0~10
	Mirror	Horizontal / Vertical
	White Balance	AUTO / AUTOext / PRESET / MANUAL
	Electric shutter	INDOOR / OUTDOOR / INDOOR-ANTI BLUR / OUTDOOR-ANTI BLUR / MANUAL (1/30~1/30000 / 12steps)
	Privacy	ON / OFF (BOX-10 Positions)
	DE-FOG	OFF / ON (MODE / LEVEL)
IR LED	-	
VIDEO		
Compression Type	H.264 (MPEG4 AVC) Main profile, Baseline profile / MJPEG	
Resolution	1st : 1920×1080 / 1280×720 / 800×600 / 704×480 / 704×400 / 640×360 / 480×272 / 320×184 2nd : 640×360 / 480×272 / 320×184 3rd : 1920×1080	
Bitrate	128Kbps ~ 5Mbps	
Frame Rate	30fps@1080p	
Streaming	1st : H.264 Stream up to 1080p 30fps 2nd : H.264 nHD Stream / 30fps 3rd : JPEG 1080p Stream / 1fps	
NETWORK & SOFTWARE		
Network & Software	Interface	1 Fast Ethernet RJ-45 port (10/100Mbps)
	Network Type	Fixed IP / DHCP
	DDNS	Not Supported
	Port	HTTP : 80 / RTSP : 554
	Protocol	HTTP / RTSP/RTP / Onvif / TCP/IP / UDP / ARP / ICMP / DHCP
	Onvif	Support
	Simultaneous Users	Max. 3 users
	DST	Support
	NTP	Support
	IP Address Filtering	TBD
	Web Browser	IE 11
	Web Monitoring	IE : ActiveX based / Other browser : JPEG based
	Web Configuration	Multi-platform web config / Desktop (Mac / Linux / Windows)
	NVR	NVRs supporting Onvif
PC CMS Software	Control Center Standard (bundle) / Control Center Pro	
Relay Server	WinRDS	
ENVIRONMENTAL & PHYSICAL		
Power Source	DC 12V ± 10% / PoE (802.3af, 36V~57V)	
Power Consumption	150mA(MAX)	
Operating Temperature	-10°C ~ 45°C	
Humidity	0% RH ~ 80% RH	
Certification	KC, FCC, CE	

* Specifications are subject to change without notice for product improvement.